

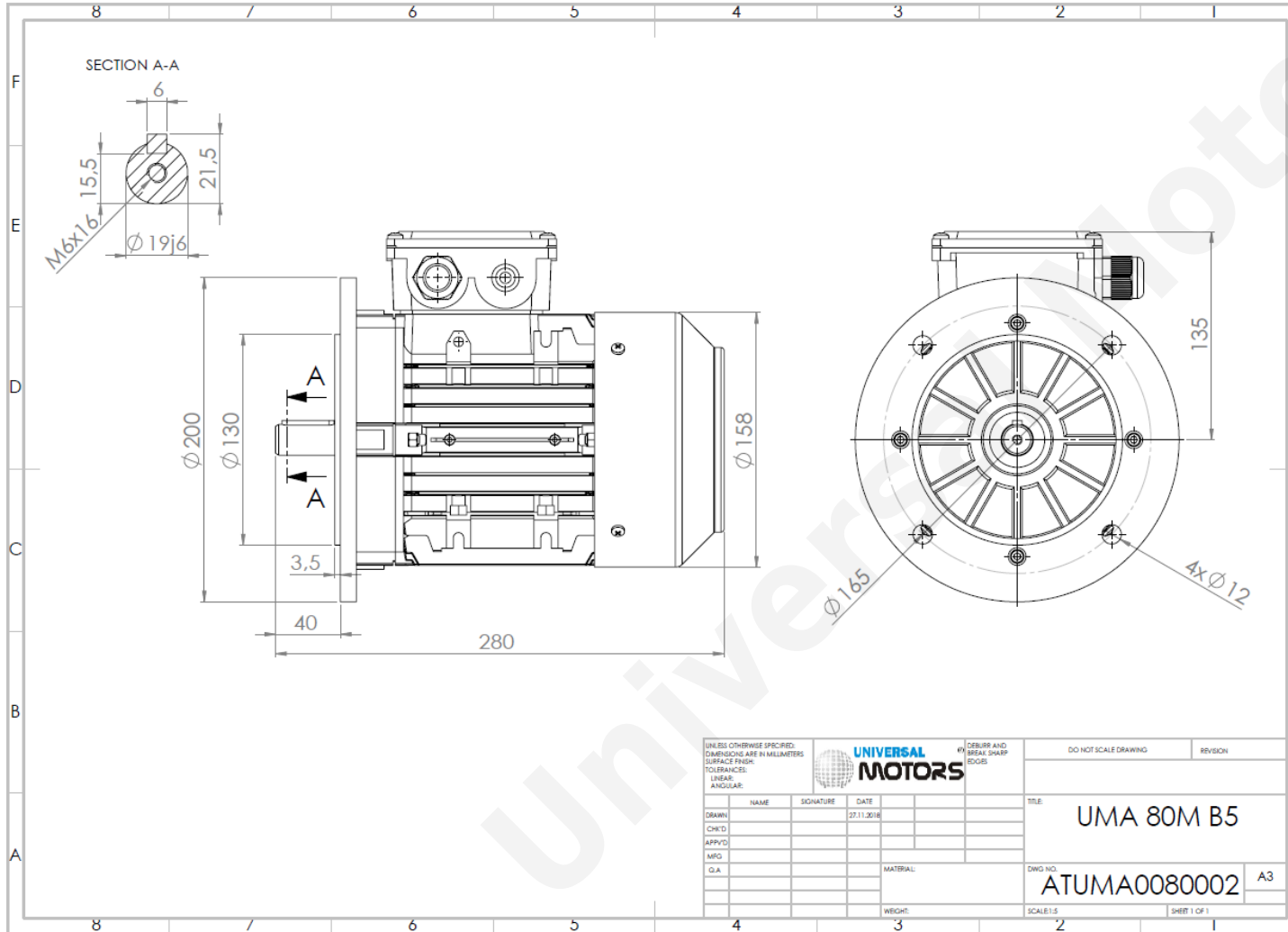

TECHNICAL DATA

Three Phase Electric Motors - Aluminum Frame
 UM3A 80 M3 2 IE3
 1.5 kW / 2 Cv
 RPM



Motor type:	UM3A 80 M3 2 IE3
Output:	1.5 kW / 2 Cv
Frequency:	50 Hz
Voltage:	400 V
Current:	3.17 A
Power factor (Cos Ø):	0.81
Poles:	2
Insulation class:	F
Temperature rise Class:	B
Efficiency 50%:	81.5 %
Efficiency 75%:	83.9 %
Efficiency 100%:	84.2 %
Torque:	4.9 N.m
Tstarting/Tnominal:	4.0
Istarting/Inominal:	9.6
Tmaximum/Tnominal:	4.0
Noise:	70 Db(A)
Weight:	12.5 Kg
Brake AC:	AC3
Torque Brake DC:	8 N.m
Bearing DE:	6204 2Z
Bearing NDE:	6204 2Z
Torque Brake AC:	10 N.m
Brake DC:	REB-05-08

Regime - S1

Altitude - 1000m

Environment Temperature - 40°C

CONTACTS:

UNIVERSAL MOTORS Tel: +351 252 299 080
 Rua de São Brás,745 Fax: +351 252 299 089
 4480-782 VILA DO CONDE Mail: geral@universalmotors.pt

* References applied only in the UK